



Pictured: Storm Torque

**Direct Drive
Storms and
Conversion Kits
now available!**

**J&D
Manufacturing**

Exhaust Fans

STORM SERIES

55" FIBERGLASS EXHAUST FANS

Which 55" Storm Exhaust Fan is best for *you*?

Storm Torque

- Maintains a continuous high level of performance with no power loss or reduction from aging belts and pulleys
- VFD compatible - *not included*
- Smooth and quiet operation



Belt Drive Storm

- Tool-less belt changing
- Shaft bearings are pre-lubricated and feature an eccentric locking collar with set screw
- Cast aluminum or galvanized prop options

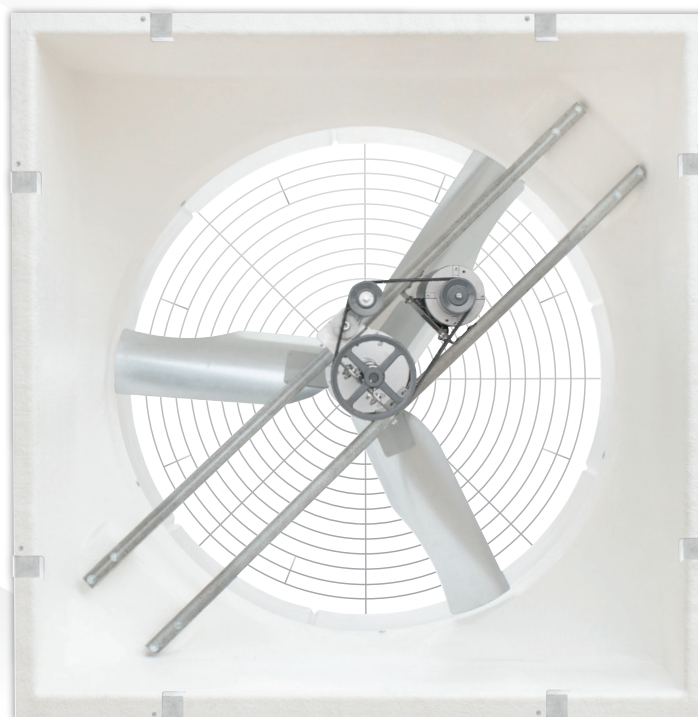

Direct Drive Storm

**Variable
Speed
No VFD
Needed**

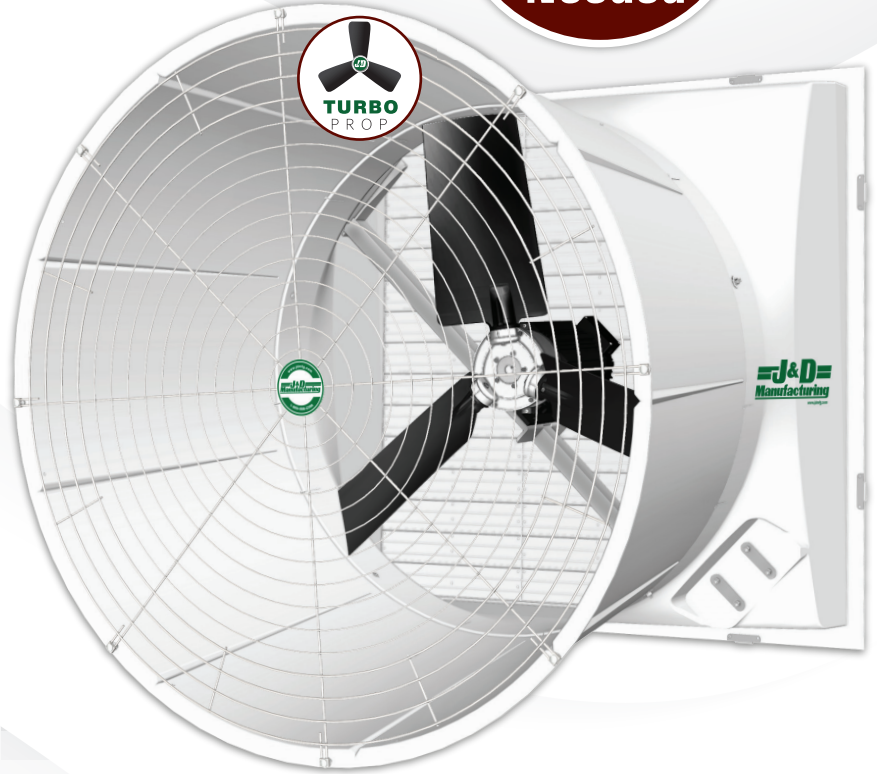
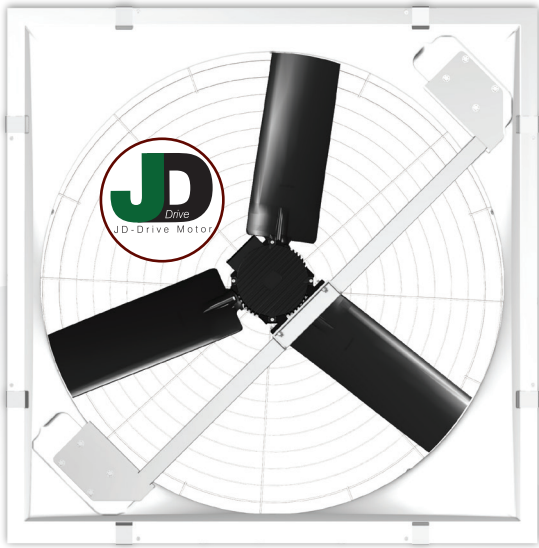

- Save money on:
 - Energy bill
 - Labor/maintenance bill
- High performance
- No maintenance

Direct Drive Storm Conversion Kit

- Easily upgrade your Belt Drive Storm to a Direct Drive Storm
- Includes installation instructions and drilling templates
- Experience high-performing, energy-efficient, maintenance-free operation when you make the change today!

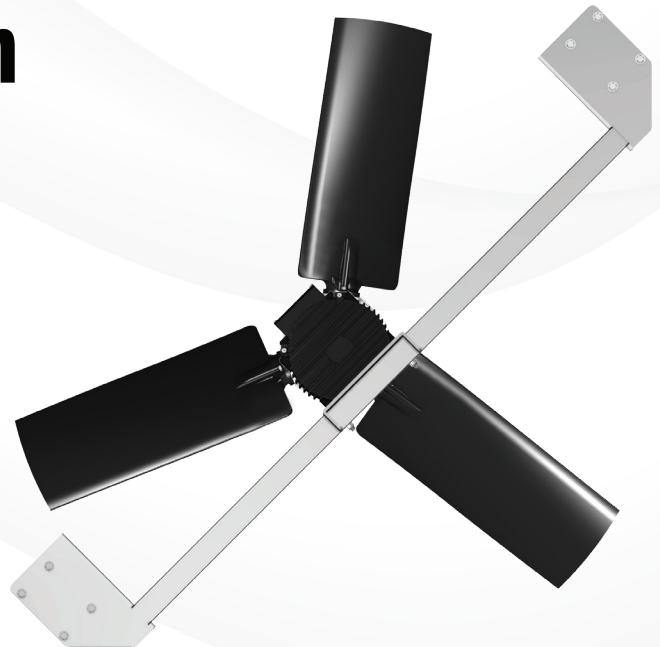

Direct



Slanted Cone

- Deep for superior performance

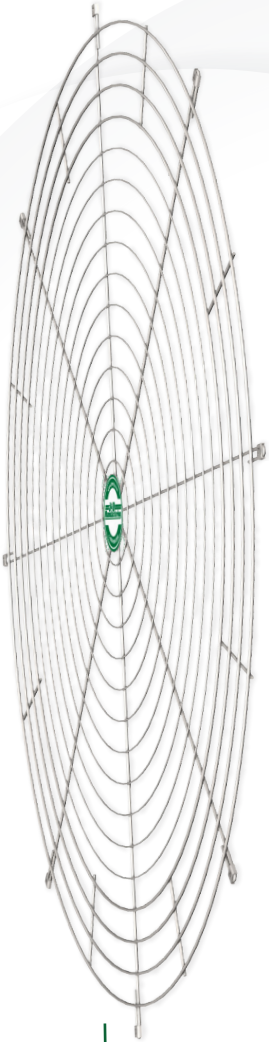

Guard

- Corrosion-resistant stainless-steel

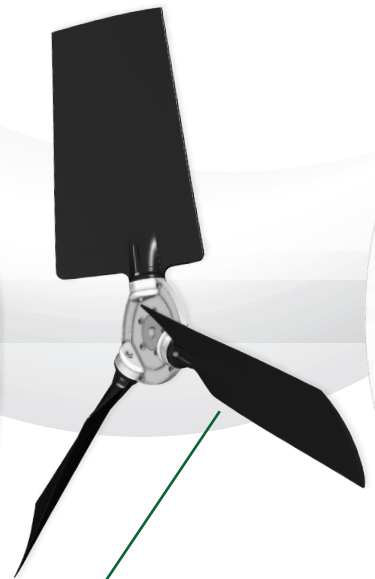
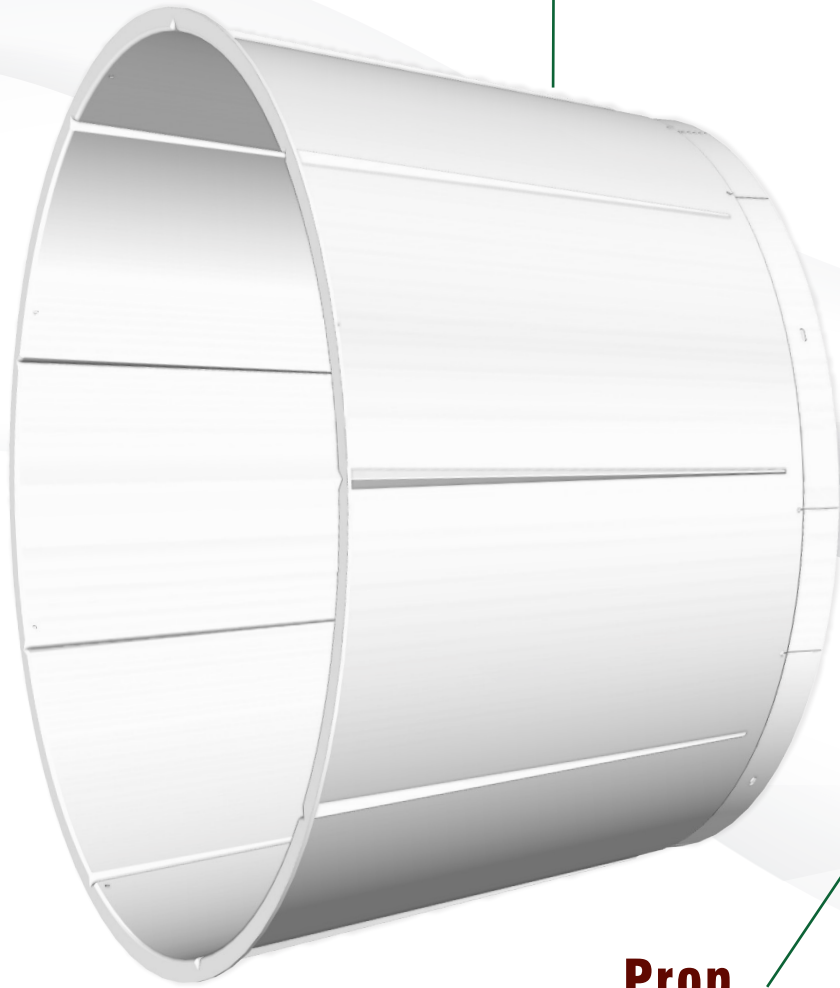

Prop

- 3 Glass-filled poly composite blades for reinforcement
- Die-cast aluminum hub
- Airfoil profile
- Optimally pitched for increased performance



Drive Storm

Motor Frame

- Motor-centric with minimal air impedance
- 304 Stainless-steel for corrosion resistance

Shutter

- Aluminum or poly options
- Corrosion-resistant

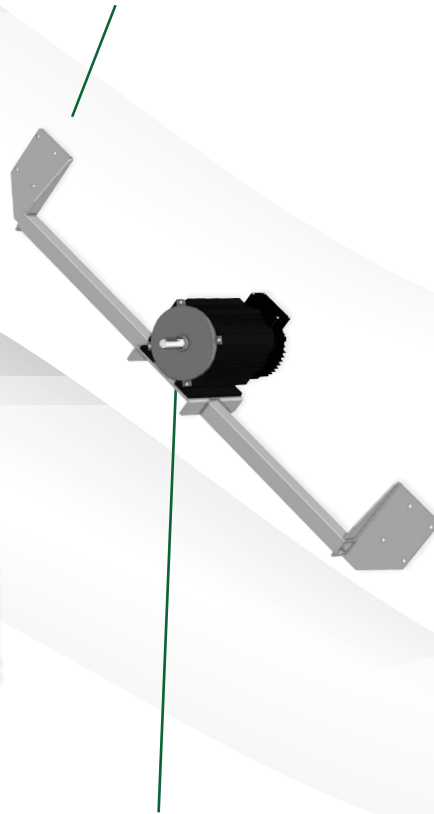

Housing

- Rugged, corrosion-resistant fiberglass
- Drainage holes to reduce moisture

JD-Drive Motor

- PM Direct Drive, efficient 2.2kW motor
- Internal Motor Drive
 - Soft Start
 - Variable speed
 - Precise and uniform speed control
- Surge Protected



- IP65-Rated
- Industrial extruded aluminum housing
- Will not interfere with RFID
- Pre-wired with 8' line power cord and 8' signal cord

Direct Drive Storm Conversion Kit

Want an upgrade? Change your Belt Drive Storm to a Direct Drive Storm with easy, step-by-step instructions!

Make the Change

Simple and easy
Upgrade what you have

Everything to Gain

Improved performance
Precise control

Nothing to Maintain

No belts
No pulleys
No greasing

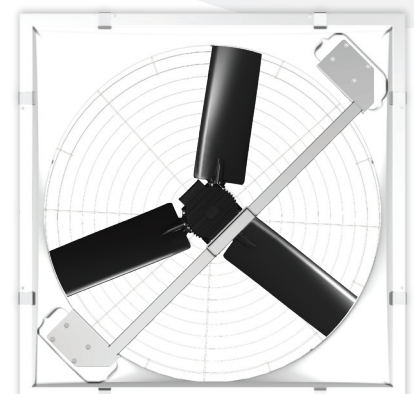
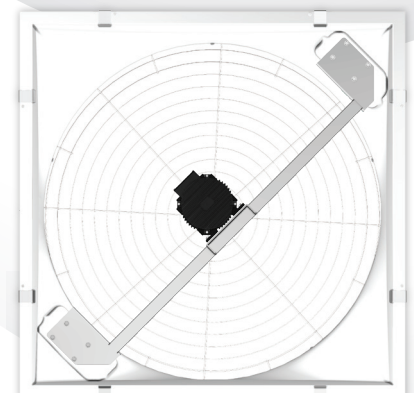
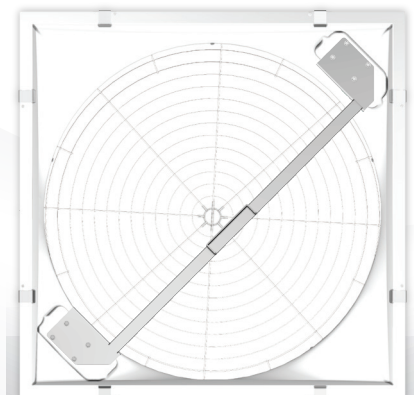
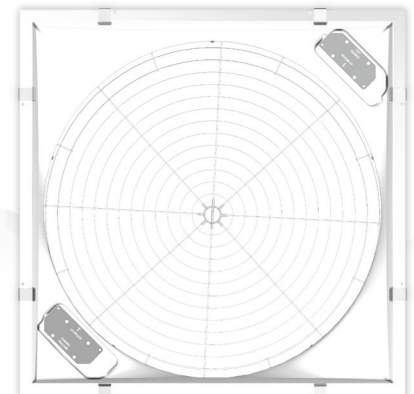
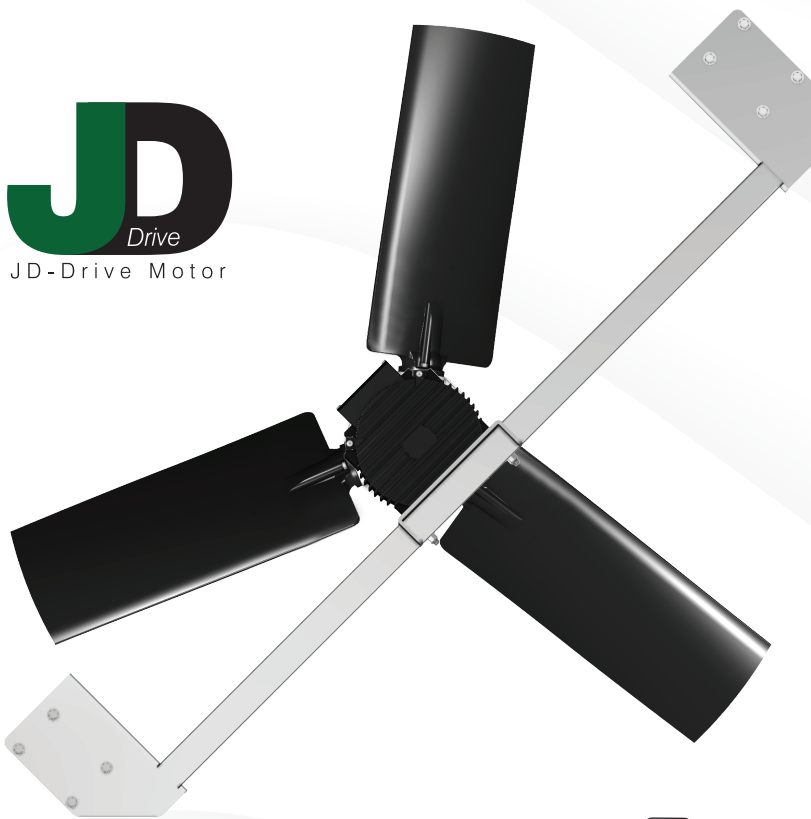

Part #	Ph	Spd	Drive	Prop
Single Phase				
VRJ55P3PM221A	1	1/Var^	PM-D	3-Ply
Three Phase wired for 190-240V				
VRJ55P3PM223B	3	1/Var^	PM-D	3-Ply
Three Phase wired for 380-460V				
VRJ55P3PM223C	3	1/Var^	PM-D	3-Ply



How can you save with the Direct Drive Storm?

- **Labor and Maintenance Costs**

No belts to change or pulleys to maintain.

- **Energy Costs**

On the hottest days when moving a lot of air is necessary, the Direct Drive Storm can keep up and outperform the other Storm fans. When running the Direct Drive Storm at maximum speed is not needed, decreasing the speed will allow you to **\$AVE BIG** on your energy bill.

Belt Drive - VSA55G3C23-SL

Average Daily Electricity Cost: \$6.49

Torque Drive - VMTA55G3C23-SL

Average Daily Electricity Cost: \$5.59

Direct Drive - VSA55P3CPM223C-SL

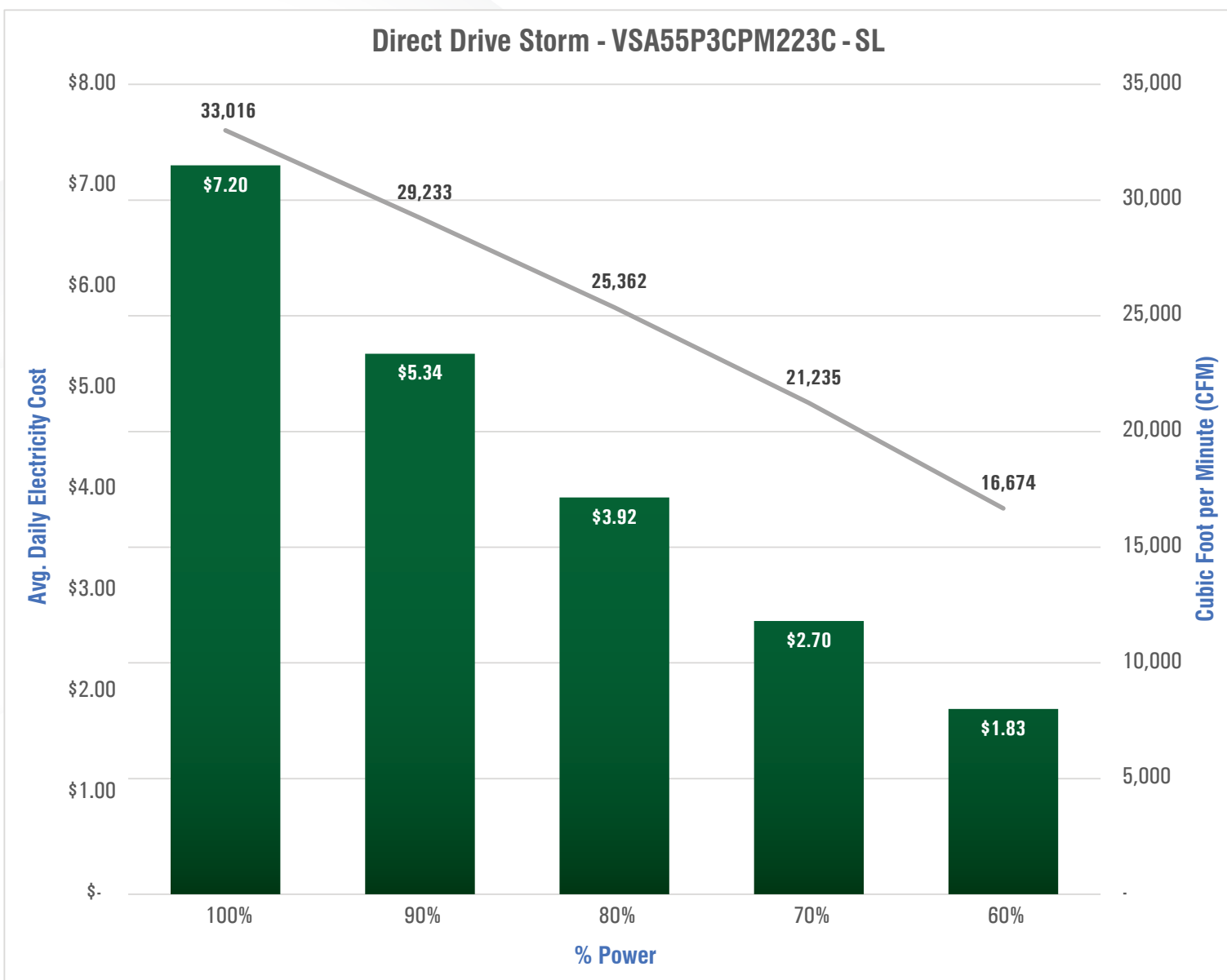



Pictured: Direct Drive Storm

**YOUR
VENTILATION
EXPERTS**

**J&D
Manufacturing**



**J&D
Manufacturing**

6200 US-HWY 12, EAU CLAIRE, WISCONSIN 54701



Family Owned & Operated in Eau Claire, Wisconsin

1-800-998-2398 | www.jdmfg.com